

Čedomir N. Radenović^{1, 2}, Ksenija P. Marković¹,
Aleksandar R. Radojčić¹, Violeta B. Anđelković¹
Aleksandar J. Kalauzi³

¹ Maize Research Institute, Zemun Polje, Belgrade, Serbia

² Faculty of Physical Chemistry, University of Belgrade, Belgrade, Serbia

³ Center for Multidisciplinary Studies, University of Belgrade, Belgrade, Serbia

INTERDEPENDENCE BETWEEN OSCILLATIONS AND TRANSIENTS OF DELAYED FLUORESCENCE INDUCTION PROCESSES IN THE THYLAKOID MEMBRANE OF THE INTACT MAIZE LEAF — RESPONSES TO EFFECTS OF INCREASED TEMPERATURES AND DROUGHT

ABSTRACT: Standard induction processes of delayed fluorescence (DF) of chlorophyll (induction signals) occur when an intact leaf segment of maize inbreds and hybrids is kept in the phosphoroscope darkroom for more than 15 minutes ($\tau > 15$ min), and at the same time the leaf is illuminated with the intermittent white light.

Resolved induction processes of DF chlorophyll into transients: A, B, C, D and E occur when the intact leaf segment of maize inbreds and hybrids is kept in the phosphoroscope darkroom for a significantly shorter period ($500 \text{ s} > \tau > 30 \text{ s}$), with the time rate t of 30 s, prior to its illumination with the intermittent white light. Induction transients: A, B, C, D and E are characterised with the time of their generation: $t_A = 31 \pm 6 \text{ ms}$ (A), $t_B = 5 \pm 0,5 \text{ s}$ (B), $t_C = 15 \pm 5 \text{ s}$ (C), $t_D = 360 \pm 20 \text{ s}$ (D) and $t_E = 670 \pm 35 \text{ s}$ (E), dynamics of changes in transients intensities (I_A, I_B, I_C, I_D and I_E) and mechanisms of their generation. The induction processes of chlorophyll DF of the intact leaf of maize inbreds and hybrids resolved into transients: A, B, C, D and E are accompanied by the occurrence and different levels of activation energy ($E_a, \text{ kJ mol}^{-1}$) that correspond to critical temperatures ranging from 28 to 33°C.

The generation mechanisms of induction transients A, B, C, D and E classify them into two groups. Transients A and B are of a physical character, while the transients: C, D, and E are of a chemical character.

It is shown that the generation of the induction transients: B, C, D and E simultaneously follows establishing of the oscillations of induction processes of the DF chlorophyll. Oscillating of induction processes of DF chlorophyll is explained by the ion ($\text{K}^+, \text{Na}^+, \text{H}^+, \text{Cl}^-$) transport mechanism across the thylakoid membrane of the intact leaf of maize inbreds and hybrids grown under conditions of air drought, increased temperatures and water deficiency in the medium.

KEY WORDS: *Zea mays*, intact leaf, thylakoid membrane, induction processes, transients, oscillations, critical temperature, activation energy, delayed chlorophyll fluorescence

INTRODUCTION

In recent times, binding complex processes of fundamental sciences with multidisciplinary ones has become the necessity. Such attempts have been made between breeding, photosynthesis, biophysical chemistry and fluorescence in maize inbreds and hybrids. The present study analyses the development of dominant processes of the stated scientific disciplines and areas of their mutual dependence and application.

Maize breeding has been intensively developed during the last 60 years. Because of such an activity, over 1,100 maize hybrids for grain and silage have been developed. Contemporary technical and technological prerequisites for conducting a modern process of breeding were provided (Duvick, 1984, Trifunović, 1986, Ivanović et al., 1995, Radenović and Šomborac, 2000). Regardless of such a colossal success in maize breeding, eagerness and enthusiasm of the total research have not been slowing down. The search for new methods and exact approaches in the completion and enrichment of the research within maize breeding and seed production was continued.

The development of maize photosynthesis was quite different. Namely, although photosynthetic processes are very spread, highly productive in their intensity, very complex in their nature, and vastly studied in their scientific actuality, their application in maize breeding is still insignificant. It is almost impossible to make a distinct, direct interrelationship between photosynthesis and breeding. Such a state is probably a consequence of the existence of several functional interrelations that unify conformational and dynamic changes within chloroplasts and their thylakoid membranes, on the one hand, and effects of numerous environmental stress factors on them, on the other hand.

Biophysical chemistry contributed, to a great extent, to connecting photosynthetic processes in the thylakoid membrane to the processes of fluorescence spectroscopy and chemical kinetics (Rubin et al., 1988, Radenović et al., 1981, 1985).

The delayed chlorophyll fluorescence (DF) phenomenon can be described as an occurrence of luminescence (bioluminescence) within the red range of the visible spectrum produced by plant systems: bacteria, algae and higher plants (maize) immediately upon their intermittent illumination (excitation) (in case of maize upon illumination of the intact leaf) (Radenović et al., 1981, 1985; Radenović, 1992, 1994, 1997, Marković et al., 1996, 1999). DF was discovered by Strehler and Arnold (1951) in their attempt to reveal a nature of induction illumination in a form of bioluminescence. Numerous studies, especially those of the last 20 years (Jursnić and Govinidje, 1982, Jursnić, 1986, Marković et al., 1996, 1999, Veselovski and Veselova, 1990, Radenović, 1992, 1994, 1997, Radenović et al., 1994a, 1994b, Kaluzi et al. 2006), revealed the direct connection between DF and photosynthetic processes, in which DF was considered as an unavoidable indicator — a susceptible „probe” for experimental photosynthetic studies in the intact leaf of maize inbreds and hybrids (Rade-

nović, 1992, 1994, 1997, Radenović et al., 1994a, 1994b, Radenović and Jeremić 1996, Marković et al., 1987, 1993, 1996, 1999). Today, as well as, in the near future, DF shall be an efficient tool, i.e. a methodological approach in studies of certain, mostly very complex photoprocesses in the light phase of photosynthesis. In relation to this approach, induction processes of chlorophyll DF, their resolution into several mutually dependent transients, generating of oscillations and rhythms and their correlation are considered as actual scientific issues. Within the scope of the stated, question arise about the activation energy and critical temperatures within activities of the total induction processes of chlorophyll DF. Hence, these issues and their interrelations are an objective of the present study.

MATERIAL AND METHODS

The studies were done with the intact leaf of the selected hybrids: ZPDC 360, ZPSC 46A, ZPSC 704 and ZPSC 71, and inbred lines: ZPR70ž and Oh43, tolerant and resistant to effects of increased temperatures and drought. The test plants were grown in pots in the glass-house under conditions of controlled and regulated air drought, relative humidity, temperatures and a reduced amount of water in the medium. Changes in the temperature were controlled and it reached the level of 38°C, although mostly ranged from 28 to 38°C. Plants were grown under such conditions through all stages of their growth and development. Recordings were done for four years in June, July and August. Maize plants were brought from the glass-house into the laboratory during morning hours (between 7 a.m. and 8 a.m.). Plants sampled in the glass-house were transversally cut in the ground internode. In the laboratory, plants were internode lengthwise placed in water. Two hours prior to the bioluminescence experiment, the plants were kept under the black ball glass. A segment of ear intact leaves was taken from such plants and placed into a chamber of the Becquerel phosphoroscope. These studies were done with 40 plants each of maize hybrids and maize inbreds.

The non-invasive photosynthetic fluorescence method was used to measure the intensity of the chlorophyll DF induction process. These measures also included the resolution of the induction curve into the transients: A, B, C, D and E, as well as, recording of the generation of oscillations and rhythms.

The improved non-invasive photosynthetic fluorescence method used to measure induction processes of chlorophyll DF is schematically presented in Fig. 1. This block scheme of the photosynthetic fluorescence method was developed at the Maize Research Institute, Zemun Polje. Measurements of changes in the induction processes of chlorophyll DF were performed after a method that had been both, in principle and details, described in previous papers (Radenović et al., 1981, 1985, Radenović, 1985, 1992, 1994, 1997, Marković et al., 1996).

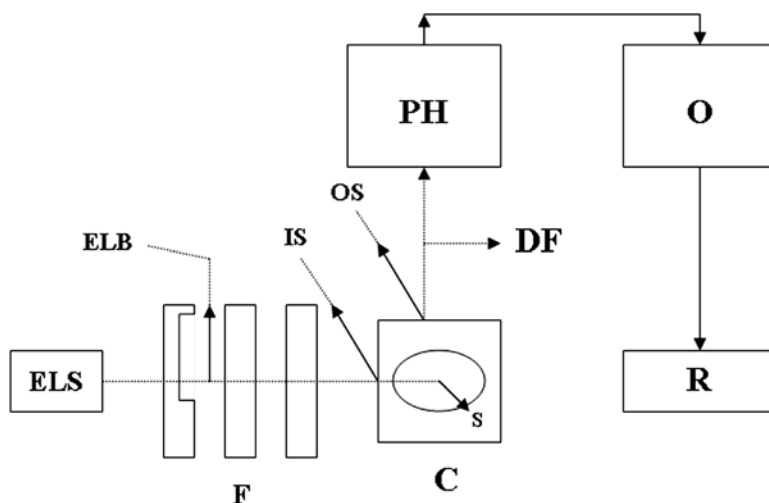

Fig. 1. — Experimental setup of the photosynthetic fluorescence method and measuring equipment for delayed chlorophyll fluorescence: **C** — dark chamber with a sample stand; **s** — sample (intact leaf segment), **F** — filters, **ELS** — excitation light source, **PH** — photo-multiplier; **O** — oscilloscope, **R** — printer, **ELB** — excitation light beam, **DF** — luminescent light (delayed fluorescence), **IS** — input dark chamber slot, **OS** — output dark chamber slot

RESULTS

1. *Standard induction processes*

Standard induction processes of delayed fluorescence (DF) of chlorophyll (induction signals) occur when an intact leaf segment of maize inbreds and hybrids is kept in the phosphoroscope darkroom for more than 15 minutes ($\tau > 15$ min), and at the same time is illuminated with the intermittent white light. Results of induction processes of chlorophyll DF are presented in Fig. 2. Under given conditions the induction curve of chlorophyll DF does not provide the possibilities of oscillations generation or the formation of transients on it: A, B, C, D and E of induction processes. The registered form of the standard induction curve of chlorophyll DF has four typical parts. The part „a” is formed very quickly, for about 1—2 s, the part „b” designates the maximum level of the induction curve intensity, the part „c” is gradually formed in the exponential trend, and at the end, the part „d” represents the stationary level of the induction curve of chlorophyll DF, Fig. 2.

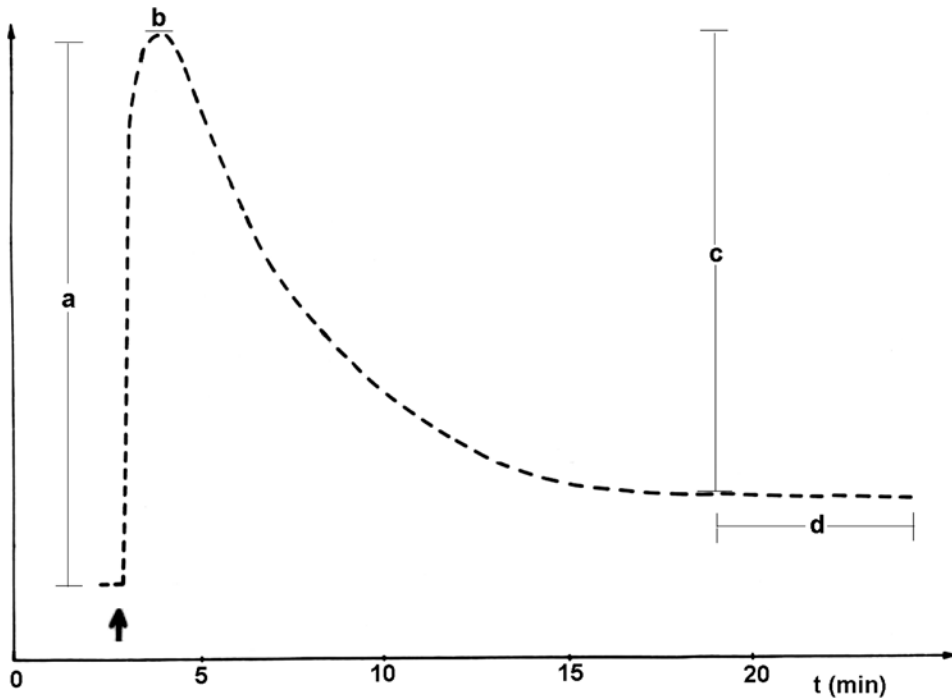

Fig. 2. — Schematic illustration of standard induction curve of chlorophyll DF typical for the intact leaf of maize inbreds and hybrids kept in the phosphoroscope darkroom longer than 15 minutes ($\tau > 15$ min)

2. Resolution of delayed chlorophyll fluorescence induction processes into transients

The resolution of the induction processes of chlorophyll DF into transients: A, B, C, D and E and the appearance of oscillations occur when the intact leaf segment of maize inbreds and hybrids is kept in the phosphoroscope darkroom for a significantly shorter period ($500 \text{ s} > \tau > 30 \text{ s}$) prior to its illumination with the intermittent white light, Fig. 3.

Results of the experimental resolution of induction processes of chlorophyll DF into transients: A, B, C, D and E are presented in Fig. 4—6 and Tab. 1.

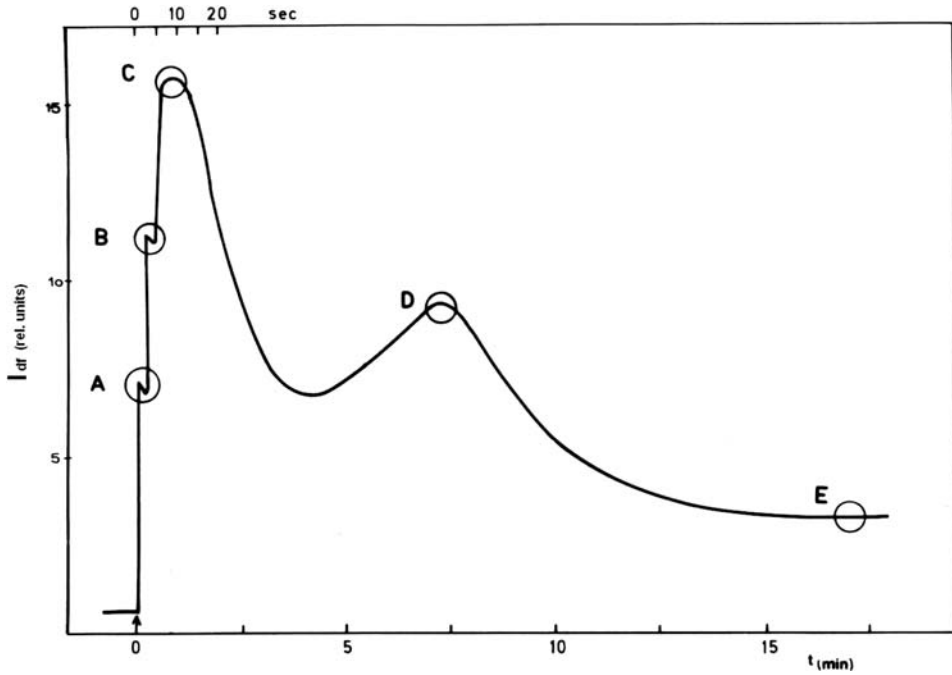

Fig. 3. — Schematic illustration of possible sites of the oscillation generation and the formation of transients: A, B, C, D, E of the induction processes of delayed chlorophyll fluorescence in the intact leaf of maize inbreds and hybrids

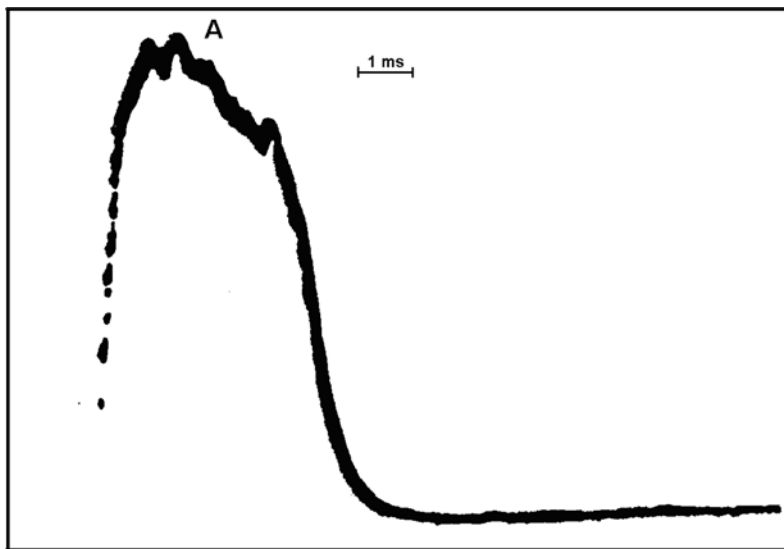

Fig. 4. — Experimental detection of the transient A of the induction processes of delayed chlorophyll fluorescence in the intact leaf of maize inbreds and hybrids with the use of the storage oscilloscope and a time scale of 1 ms

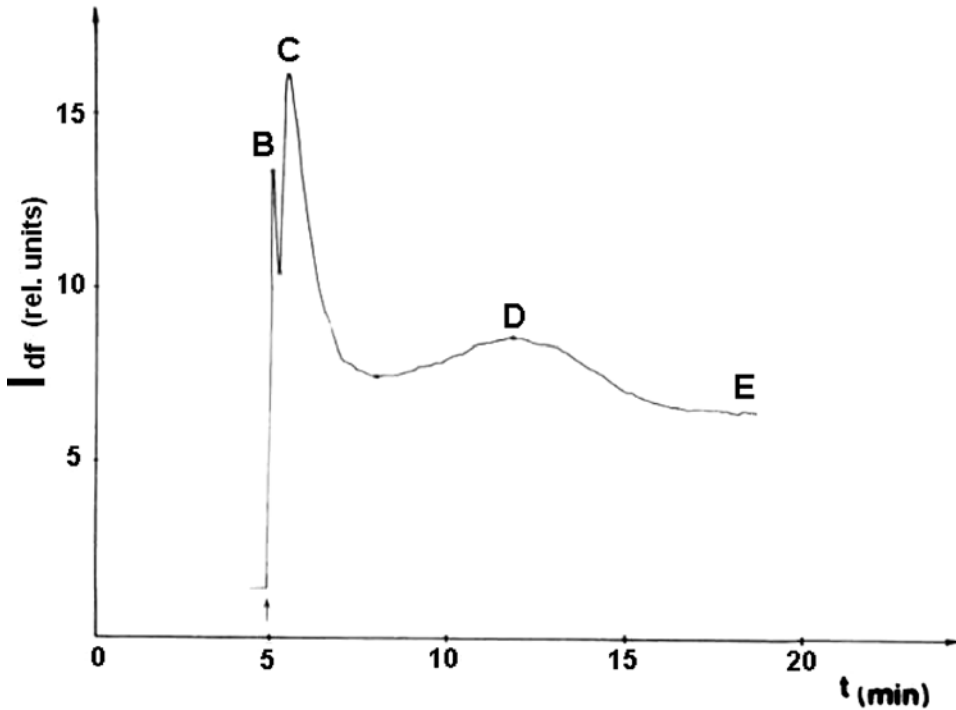

Fig. 5. — Typical presentation of the experimental results on the resolution into transients: B, C, D and E of the induction processes of delayed chlorophyll fluorescence in the intact leaf of maize inbreds and hybrids for the time t in seconds ($500 \text{ s} > \tau > 30 \text{ s}$)

Tab. 1. — Time parameters of transients, A, B, C, D and E of the induction processes of delayed chlorophyll fluorescence in the intact leaf of studied maize inbreds and hybrids at 25°C

Time of generation of transients: A, B, C, D and E	Transients of the induction processes of delayed chlorophyll fluorescence in the intact leaf of maize inbreds and hybrids				
	A: t_A , ms	B: t_B , s	C: t_C , s	D: t_D , s	E: t_E , s
Time of the beginning of transient generation	2—4	0.8—1.0	9—11	110—130	180—240
Time of transient generation with the maximum intensity	28—32	6—7	13—17	180—200	380—480 (decrease)
Longest time of transient generation	75—80	8—9	21—23	480—500	8400
Average time of transient generation	31 ± 6	5 ± 0.5	15 ± 5	360 ± 20	670 ± 35

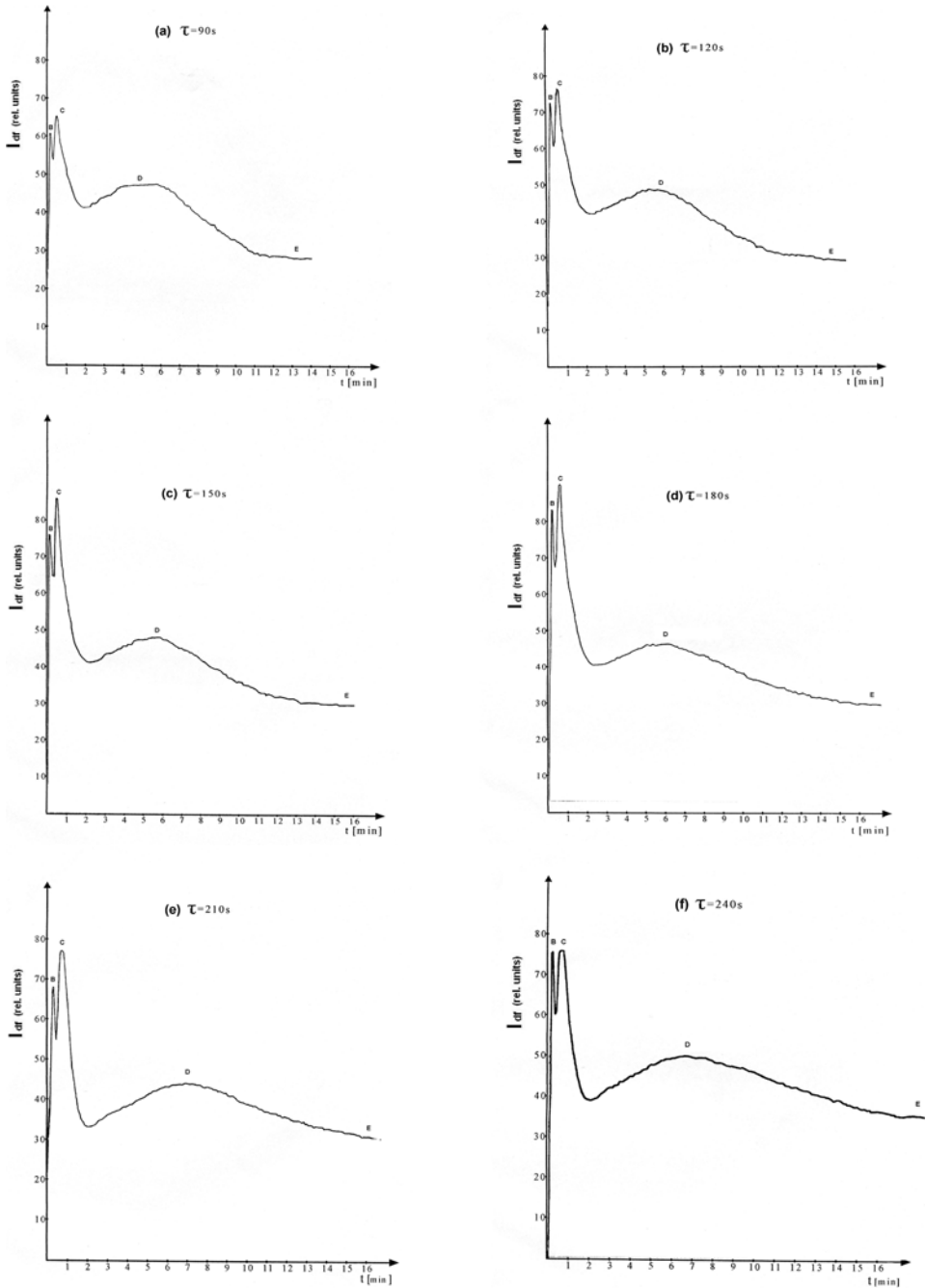

Fig. 6a-f — Experimental results on the resolution of the induction curve of delayed chlorophyll fluorescence into transients: B, C, D and E for the following values of t : 90s, 120s, 150s, 180s, 210s and 240s

3. Dynamics of changes in intensities of transients of delayed chlorophyll fluorescence induction processes in dependence on temperature

Obtained results on changes in the intensity of induction transients: B, C, D and E in observed maize inbreds and hybrids in dependence on temperature are presented in Fig. 7 and Tab. 2.

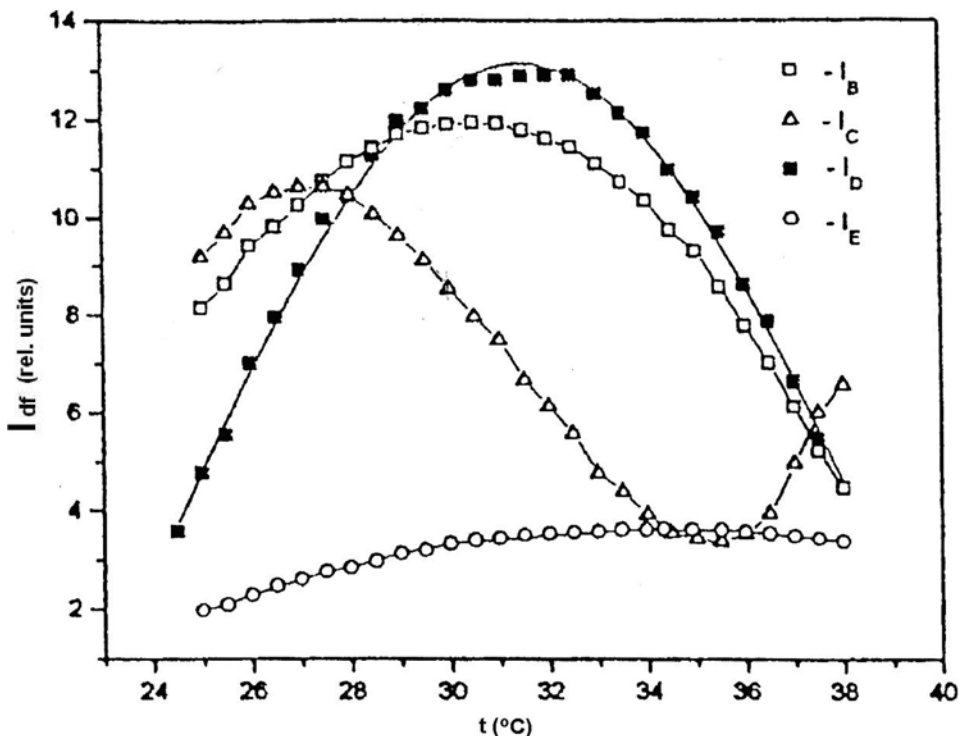

Fig. 7. — Dynamics of changes in intensities of transients B, C, D and E of delayed chlorophyll fluorescence induction processes in dependence on temperature

Tab. 2. — Temperatures of the transition period of transients: B, C, D and E of delayed chlorophyll fluorescence induction processes in the intact leaf of studied maize inbreds and hybrids

Previous intact leaf dark period (τ , s)	Temperatures of transition period, t °C			
	Transient B	Transient C	Transient D	Transient E
30	33.3 ± 0.2	28.5 ± 2.5	31.6 ± 0.2	30.8 ± 0.2
60	23.4 ± 0.3	32.7 ± 3.0	25.4 ± 0.3	22.0 ± 0.3
90	19.5 ± 0.2	25.8 ± 0.3	26.5 ± 0.2	20.5 ± 0.4
120	17.9 ± 0.2	25.0 ± 0.5	22.5 ± 0.2	21.0 ± 0.4
150	24.7 ± 0.4	26.3 ± 0.4	22.5 ± 0.2	25.0 ± 0.3
180	24.0 ± 0.3	26.3 ± 0.3	23.1 ± 0.2	23.8 ± 0.5
210	24.3 ± 0.3	31.0 ± 0.4	22.0 ± 0.2	22.2 ± 0.3
240	26.1 ± 0.3	32.0 ± 0.4	23.8 ± 0.2	22.8 ± 0.5

Fig. 7 shows that changes in the intensities of transients B and D are similar. In the beginning, the intensity of the transient B (I_B) increases at the temperature range of 24–29°C, then reaches and maintains the maximum value within the temperature range of 29–32°C, and after that, it gradually decreases at the temperature range of 32–38°C. The intensity of the transient D (I_D) shows the similar trend, but its parabola has a somewhat steeper slope (Fig. 7). On the other hand, the dynamics of changes in the intensity of the transient C (I_C) is different. It is an inverse sigmoid (in the beginning, the intensity of the transient C increases at the temperature up to 26°C, when it reaches its maximum, then it gradually decreases at the temperature of 35.5°C at which it reaches its minimum and then again it increases up the temperature range of 35.5–38.0°C) (Fig. 7). Changes in the intensity of the transient E (I_E) are standard and expected.

4. *Activation energy of transients of delayed chlorophyll fluorescence induction processes*

Tab. 3 presents results on the activation energy (E_a) of transients B, C, D and E of chlorophyll DF induction processes

Tab. 3. — Activation energy of transients: B, C, D and E of delayed chlorophyll fluorescence induction processes in the intact leaf of studied maize inbreds and hybrids

Previous intact leaf dark period (τ , s)	Activation energy (E_a , kJ mol ⁻¹)			
	Transient B	Transient C	Transient D	Transient E
30	65.37	83.69	266.98	32.08
60	32.90	23.80	39.66	26.28
90	51.81	14.03	27.83	53.68
120	52.96	47.68	63.68	92.53
150	30.07	68.52	93.53	106.62
180	25.97	75.05	116.27	106.32
210	22.35	34.43	132.19	92.74
240	21.60	30.09	131.80	74.49

The dynamics of changes in the intensities of transients: I_B , I_C , I_D and I_E (Fig. 7), changes in the phase transition temperature (Tab. 2) and the activation energy (Tab. 3) do not proceed according to a certain established rule, which indicates the rapidity of their occurrence and the total complexity of photosynthetic and fluorescence system.

5. *The correlations of transients with oscillations in the delayed chlorophyll fluorescence induction processes*

Experimental results on dependency of intensities of transients B, C, D and E and oscillations in chlorophyll DF induction processes in studied maize inbreds and hybrids are presented in Fig. 8–11.

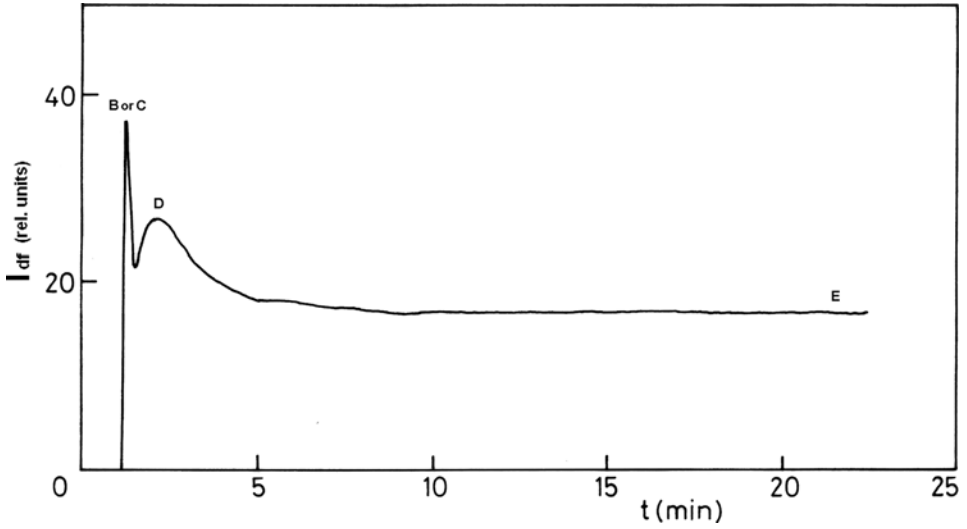

Fig. 8. — Generation of the standard induction curve of delayed chlorophyll fluorescence with transients B or C, D and E in the intact leaf of studied maize inbreds and hybrids grown under common physiological conditions

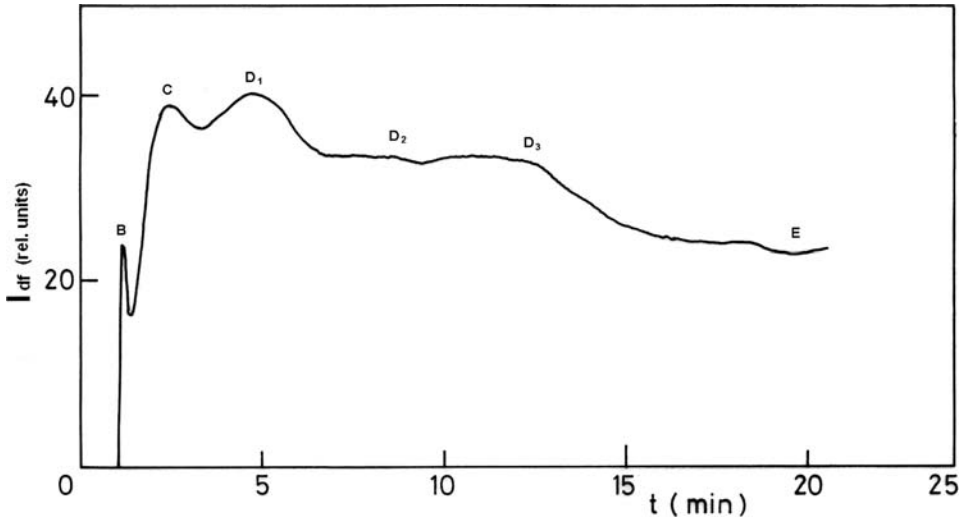

Fig. 9. — Generation of the excited state of the induction curve of delayed chlorophyll fluorescence with transients B, C, D₁, D₂, D₃ and E in the intact leaf of studied maize inbreds and hybrids grown under conditions of weak air drought

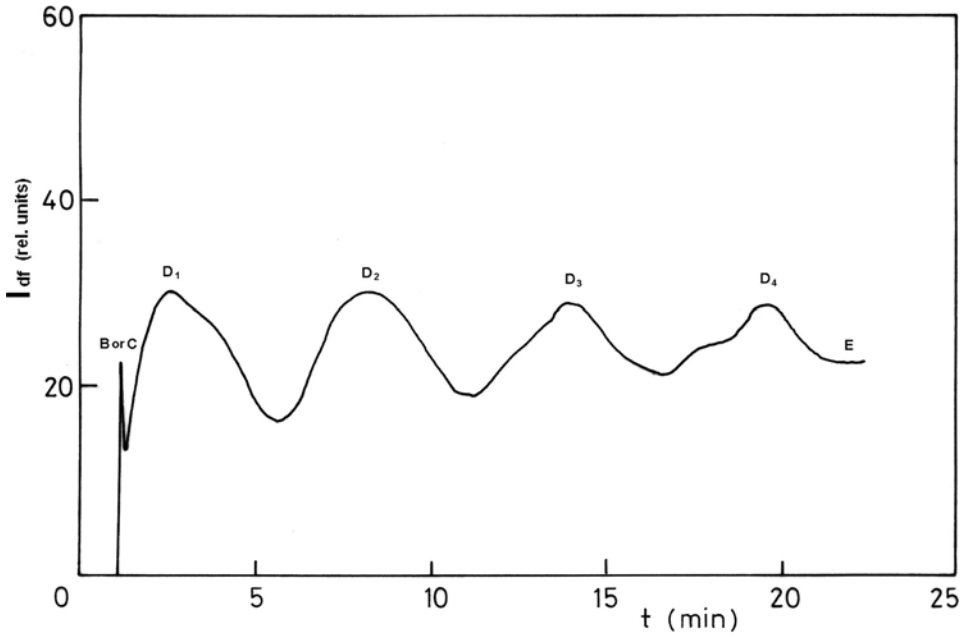

Fig. 10. — Generation of the fluctuation of induction curve of delayed chlorophyll fluorescence with transients B or C, D₁, D₂, D₃, D₄ and E in the intact leaf of studied maize inbreds and hybrids grown under conditions of severe air drought

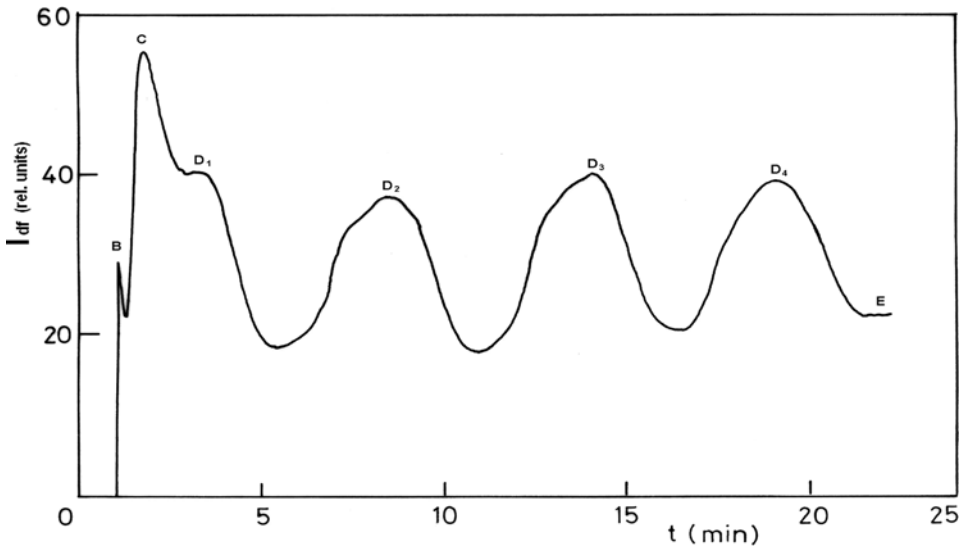

Fig. 11. — Generation of the oscillations of the induction curve of delayed chlorophyll fluorescence with transients B, C, D₁, D₂, D₃, D₄ and E in the intact leaf of studied maize inbreds and hybrids grown under conditions severe air drought and reduced water in the medium

If observed maize inbreds and hybrids are grown under conditions of different intensities of air drought, decreased relative humidity and higher temperatures, obtained fluorescence responses of induction processes will be not only with transients but also with oscillations.

According to such studies the intensities of transients: B, C, D and E of chlorophyll DF induction processes are connected to the induction and the establishment of processes of instability, excited state, fluctuations and oscillations in thylakoid membranes in the intact leaf of maize inbreds and hybrids. Such a response was obtained in observed maize inbreds and hybrids that were tolerant and resistant to drought, Fig. 8—11.

DISCUSSION

In the experimental resolution of chlorophyll DF induction processes, transients B, C, D and E were initially revealed by the application of the standard procedures for chlorophyll DF detection (Radenočić et al., 1981). Much later, the transient A was revealed (Radenočić, 1997). It was much more difficult to be detected. It was necessary to provide a storage oscilloscope and to connect it to the equipment set up to register chlorophyll DF induction processes. Induction transients: A, B, C, D and E are characterised by their general and physical and chemical parameters, i.e. time of their generation (t_A , t_B , t_C , t_D and t_E), dynamics of changes in transient intensities (I_A , I_B , I_C , I_D and I_E) and mechanisms of their generation, Tab. 1 and Fig. 7.

Generation mechanisms of transients A, B, C, D and E

The generation mechanism of the transient A is explained by its connection to the primary photochemical act that predominantly affects the formation of the induction dipole within the photosystem II reaction centre. The generation of this transient is a result of the orientation of electric dipoles in the thylakoid membrane under effects of the illumination with the intermittent white light that excites them. The dipole orientation induces an electric field. Such dipoles define the transient A pointing out to its physical nature and its effects on the delayed chlorophyll fluorescence induction processes.

The transient B generation is primarily attributed to the formation of the electrochemical gradient across the thylakoid membrane after the illumination of the intact leaf segment with the intermittent white light. More precisely, this transient strongly depends on the electrical component of the electrochemical gradient (DF). The transient B is a direct product of the thylakoid membrane excitation under the illumination with the intermittent white light. It is believed that a photodipole interacts with other membranous structures and that this interaction causes the excitation that is in fact expressed as the transient B of the chlorophyll DF induction processes. As this interaction is rapid, more rapid than chemical reactions, its basis is not purely chemical but much more physical.

It is considered that the transient C generation depends on photosensitive reactions centres. These centres depend on t (previous intact leaf dark period), i.e. their number increases in dependence on t , and then conformational and functional changes occur in certain protein structures that determine mutual position of acceptors (Cha) in the reaction centre. This transient has kinetic characteristics similar to the transient B as it is susceptible to the presence of valomycin, which is capable to eliminate the electrochemical gradient (Radenočić, 1997, Radenočić et al., 2003, 2007, Marković et al., 1999; Kalauzi et al., 2006). The transient C depends on the electron transport between two photosystems (PS II and PS I). In particular, the intensity of this transient increases with the increase of the accumulation of X^- (secondary PS I electron acceptor in the reduction form until it reaches its peak that corresponds to the electrochemical gradient maximum). The X^- accumulation corresponds to the accumulation of PS II P_h^- and Q^- . Similarly, the drop in the transient C intensity is caused by the decrease of the electrical component of the electrochemical gradient ($\Delta\Psi$), and cation diffusion from thylakoids. It is in fact, the indication of the dissipation of the electrochemical gradient. Kinetic characteristics of these transients depend on the duration of the dark period. The prolongation of the dark period leads to the decrease in the transient C intensity and simultaneously to the increase in the transient D intensity.

The transient D of the chlorophyll DF induction curve appears, and therefore it is easily detected, only when its observation is performed outside of the optimal temperature range ($28^\circ\text{C} < \tau < 16^\circ\text{C}$). Hence, this transient primarily depends on the temperature. The transient D also depends on the electrochemical gradient, particularly on its proton component (DpH). The formation of the electrochemical gradient relates to „energisation” of thylakoids, which are dynamic entities whose structures and functional properties response to environmental stimuli. Therefore, if the transient D amplitude increases, corresponding changes in the thylakoids structure will occur in the course of protonation and phosphorylation. In case of the transient D drop, changes in thylakoids structure cause mutual nearing of photosystems I and II and alleviate the intersystem electron transmission. It was determined that transients C and D can be kinetically expressed by two consecutive chemical reaction of the first order with different rate constants, Tab. 4 (Radenočić et al., 1985).

Tab. 4. — Rate constants of chemical reactions in the thylakoid membrane of the intact leaf of maize inbreds and hybrids for transients C and D of delayed chlorophyll fluorescence induction processes at 25°C

Intact leaf of maize inbreds and hybrids	Rate constants of chemical reactions	
	Transient C	Transient D
ZPDC 370	$k_{C1} = 5,13 \times 10^{-3}s^{-1}$ $k_{C2} = 2,41 \times 10^{-3}s^{-1}$	$k_{D1} = 3,98 \times 10^{-3}s^{-1}$ $k_{D2} = 2,04 \times 10^{-3}s^{-1}$
ZPSC 46A	$k_{C1} = 5,41 \times 10^{-3}s^{-1}$ $k_{C2} = 6,13 \times 10^{-3}s^{-1}$	$k_{D1} = 4,88 \times 10^{-3}s^{-1}$ $k_{D2} = 2,10 \times 10^{-3}s^{-1}$
ZPSC 704	$k_{C1} = 2,60 \times 10^{-3}s^{-1}$ $k_{C2} = 8,30 \times 10^{-3}s^{-1}$	$k_{D1} = 3,70 \times 10^{-3}s^{-1}$ $k_{D2} = 3,20 \times 10^{-3}s^{-1}$
ZPSC 71	$k_{C1} = 2,82 \times 10^{-3}s^{-1}$ $k_{C2} = 3,16 \times 10^{-3}s^{-1}$	$k_{D1} = 3,55 \times 10^{-3}s^{-1}$ $k_{D2} = 4,28 \times 10^{-3}s^{-1}$
ZPR70ž	$k_{C1} = 4,80 \times 10^{-3}s^{-1}$ $k_{C2} = 6,10 \times 10^{-3}s^{-1}$	$k_{D1} = 3,50 \times 10^{-3}s^{-1}$ $k_{D2} = 3,20 \times 10^{-3}s^{-1}$
Oh 43	$k_{C1} = 5,10 \times 10^{-3}s^{-1}$ $k_{C2} = 6,30 \times 10^{-3}s^{-1}$	$k_{D1} = 4,60 \times 10^{-3}s^{-1}$ $k_{D2} = 2,90 \times 10^{-3}s^{-1}$

The stationary level is regularly established in the course of recording of all induction signals of delayed chlorophyll fluorescence. In case of its dissipation, this level is designated as the transient E. The stationary level of the chlorophyll DF induction curve is established by the drop of the electrochemical gradient across the thylakoid membrane and it maintains the slow changes in the intensity of the chlorophyll DF induction processes. Furthermore, the stationary level of the chlorophyll DF induction curve generally rises with the temperature increase. However, this level depends on the state of photosynthetic structures in observed intact leaves of maize inbreds and hybrids. Under particular conditions including effects of environmental factors, the transient E can take oscillatory properties (R a d e n o v i ć et al., 1981).

The correlations of transients with oscillations in induction processes

Studies on oscillatory phenomena in biological systems, and especially in photosynthetic structures, are relatively a novel subject matter. A great number of issues within the field of oscillatory phenomena have been just set up, initiated or only processed to some extent. Namely, a matter of dispute concerns the correlation of transients of chlorophyll DF induction processes with provoking and establishing instabilities, excited states, fluctuations and oscillations in thylakoid membranes of segments of the maize intact leaf. Such a response was obtained in maize inbreds and hybrids that were tolerant and resistant to drought. The test plants were grown in pots with soil in the glass-house under conditions of controlled and regulated air drought, lower relative humidity, temperature and a reduced amount of water in the medium.

Studying chlorophyll DF induction processes in the intact leaf of maize grown under common and physiological conditions the obtained response was in a form of a chlorophyll DF induction curve in which transients were only

partially expressed, Fig. 8. Instabilities, excited states, fluctuations and oscillations were not detected in them. However, if observed maize inbreds and hybrids had been grown under conditions of weak air drought then fluorescence responses with rhythmical characteristics were obtained and significantly differed from the common chlorophyll DF induction curve. Such a response with the oscillatory characteristics of chlorophyll DF induction processes can have an excited state of the induction curve that remains within the region of its stationary level, which can be affected by transients, Fig. 9. Rhythms can occur in the form of fluctuations of the chlorophyll DF induction curve and can be significantly affected by transients, Fig. 10. At the end, oscillations of the chlorophyll DF induction curve can be expressed in a form of a regular oscillation of the delayed chlorophyll fluorescence stationary level, Fig. 11.

The correlation of transients of chlorophyll DF induction processes with phenomena of instabilities, fluctuations and oscillations is difficult to explain. However, it is believed that transients B, C and D initiate and provoke the stated phenomena (Radenović et al., 1981). Two explanations of their correlations will be briefly presented in this paper. The first explanation is based on the existence of structural and functional regulation within the system of chloroplast of the maize intact leaf in the process of its formation. In other words, this explanation is based on the existence of active reversible links in the system functioning in the rhythmic fluctuating regime. It means that when a photosynthetic apparatus of the intact leaf functions under conditions that it depends on the environmental factors, a periodicity (rhythmicity) of the temporal dependence of structural and functional parameters of the maize leaf occurs.

The starting point of the second explanation is that the phenomena of instabilities, fluctuations and oscillations in the assumed liquid mosaic membranous model can be correlated with the excited state of the thylakoid membrane. The excited state of the thylakoid membrane implies complex conformation changes, and by it, significant functional changes. Namely, proteins migrate and oscillate on the surface of the thylakoid membrane (changes in the surface charge density) and provoke transport process of K^+ , Na^+ , H^+ and Cl^- (Radenović, 2001). It is quite possible to expect that changes in ions within and across the thylakoid membrane reflect on the stability of the stationary level of the chlorophyll DF induction curve in such a way that it acquires properties of the oscillator. It should also be mentioned that one of the pathways of normalising the structure and function of the excited thylakoid membrane leads via the process of phospholipid oxidation, and then via a process of resynthesis of non-oxidative products. These facts are also favoured by the information that the active transport and passive exit of cations and anions are closely related to the periodicity of the hydrolysis and resynthesis of phospholipids, as well as, that they affect activities of macroenergetic compounds (ATP and ADP) in the thylakoid membrane, which can express instabilities, fluctuations and can assume the property of the oscillator and therefore it can transmit them on the chlorophyll DF induction processes (Radenović et al., 1981; Radenović, 2001).

CONCLUSION

According to gained and presented results it can be concluded that the improved photosynthetic-fluorescence method can be successfully applied in the studies on chlorophyll DF induction processes that are resolved into transients A, B, C, D and E and in which oscillations can be generated.

The interdependence of oscillations and induction transients A, B, C, D and E occurs in the intact leaves of studied maize inbreds and hybrids grown in the glass-house under different conditions of controlled and regulated air drought, different % of relative humidity, temperature effects and the water deficiency in the medium.

The following properties of the chlorophyll DF induction processes were determined: this study presents conditions under which standard induction processes of chlorophyll DF were established in the intact leaf of maize inbreds and hybrids and conditions under which the induction signal resolved into transients. The existence of transients A, B, C, D and E was identified. Temporal, physical and chemical parameters for stated transients were shown in the present study. Mechanisms of their occurrence were explained.

The following properties of oscillations of the chlorophyll DF induction processes were determined: this study presents conditions under which the excited state occurred, fluctuations appeared and oscillations were established in the thylakoid membrane of the intact leaf of maize inbreds and hybrids; the hypothesis on the mechanism of the generation of oscillations; the interdependence of the generation of oscillations and transients of chlorophyll DF induction processes was explained in the present study.

ACKNOWLEDGMENT

These 30-year studies encompassing the development of methods, experimental investigations and theoretical discussions were mainly supported by the Maize Research Institute, Zemun Polje, and partially by the Ministry of Science of Serbia and Yugoslavia (projects: 03E22, 12E11, 143043, 142025).

REFERENCES

- Du Vick, D. N. (1984): *Genetic contribution to yield gains of U.S. hybrid maize, 1930—1980*. In: W. R. Fehr, ed. „Genetic contributions to yield gains of five major Crop Plants”. CSSA, Spec. Publ. 7, pp. 15—47, CSSA and ASA, Madison, WI.
- Ivanović, M., R. Petrović, G. Drinić, V. Trifunović, L. Kojić, M. Vuković, M. Mišović, G. Radović, D. Ristanović, Z. Pajić, B. V. Trifunović, D. Jelovac (1995): *Pedeset godina selekcije ZP hibrida kukuruza*. In: „Oplemenjivanje, proizvodnja i iskorišćavanje kukuruza — 50 godina Instituta za kukuruz „Zemun Polje”, Beograd.

- Jursnić and Govindjee (1982): *Effects of hydroxylamine and silicomolybdate on the decay in delayed light emission in the 6–100 μ s range after a single 10 ns flash in pea thylacoides*, Photosynthesis Research 3 (3): 161–177.
- Jursnić, P. (1986): *Delayed fluorescence: Current Concepts and Status*. In: „Light Emission by plants and Bacteria”, Ed: Govindjee, Ames and Fork CD, Academic Press, Orlando, Fl. USA, pp. 291–328.
- Kalauzi, A., D. Marković and Č. Radenović (2006): *Transients of Delayed Fluorescence Induction Signal and Photosynthetic Antennas: A Possible Relationship. Mathematical Modeling Approach*. Russian Journal of Plant Physiology Vol. 53, No. 3, pp. 289–297.
- Marković, D. Z., Kalauzi, A. and Radenović, Č. N. (2001): *Delayed fluorescence induction transients: mathematical modelling based on the chosen kinetic models*, Gen. Physiol. Biophys., Vol. 20, pp. 303–313.
- Marković D., Č. Radenović, L. Rafailović, S. Žeraić, M. Marković (1999): *Temperature dependence of delayed fluorescence induction curve transients*. General Physiol. Biophysics. Vol. 18, No 3, str. 257–267.
- Marković D., M. Jeremić, Č. Radenović (1996): *Savremena biofizika. 4. Zakasnela fluorescencija hlorofila*. Izdavač „Velarta”, Beograd, str. 1–105.
- Radenović, C., Jeremić, M., Marković, D., Kalauzi, A. (2003): *Tranzijenti indukcionog signala zakasnele fluorescencije hlorofila i njihovo kinetičko ponašanje*, Zbornik posvećen profesoru dr Dušanu Vučeliću, 123–134, Beograd.
- Radenović Č. (1992): *Proučavanje fotoindukovane bioluminescencije kod lista kukuruza*. Savremena poljoprivreda 40 (6) pp. 15–38.
- Radenović Č. (1994): *A study of delayed fluorescence in plant models: photosynthetic, transportation and membrane processes*. J. Serb. Chem. Soc. 59 (9): 595–617.
- Radenović Č., D. Marković, M. Jeremić (1994b): *Delayed chlorophyll fluorescence in plant models*. Photosynthetica 30 (1): pp. 1–24.
- Radenović Č., M. Jeremić, D. Fidler, D. Marković, Ž. Vučinić (1985): *A kinetic study of delayed fluorescence induction and its dependence on preceding darkness*. Period. biol. 87 (2): 304–306.
- Radenović Č., M. Somborac, eds. (2000): *Kukuruz na pragu trećeg milenijuma – sećanja, kazivanja i predviđanja*. Izdavač: Institut za kukuruz „Zemun Polje”, Beograd
- Radenović, Č. (2001): *The mechanism of oscillatory ion transport and biopotential across exited cell membrane*. Proceedings for natural sciences, Matica Srpska 100, 91–104, Novi Sad.
- Radenović, Č. & M. Jeremić (1996): *The study of delayed light emission in plant models*. Arch. biol. Sci. 48: 1–18.
- Radenović, Č. (1997): *Induction processes and activation energy of delayed chlorophyll fluorescence*. Proceedings for Natural Sciences of Matica Srpska 93: 5–14.
- Radenović, Č., A. Kalauzi, K. Konstantinov and G. Drinić (2007): *Dynamics of generating transients of delayed fluorescence induction signal and photosynthetic antennas: a possible relationship. Mathematical modeling approach*. Proc. Nat. Sci. Matica Srpska Novi Sad, No 112, 5–26

- Radeno vić, Č., Vučinić, Ž., Fidler, D., Penčić, M. (1981): *Contribution to the study of delayed light emission rhythms in the maize leaf (Zea mays L.)*, *Studia biophysica* 86: 143—147.
- Radeno vić, Č. (1985): *Boltzmanov izraz za aktivacionu energiju i njegova primena u biološkim sistemima*. Interna publikacija Instituta za kukuruz „Zemun Polje” Beograd, pp 1—9.
- Rubin, A. B., Focht, A. A., Venediktov, P. S. (1988): *Some kinetic properties of electron-transfer processes on the primary photosynthesis reaction*, *Transaction of the Moscow Society of Naturalists* 28:172—184.
- Strehler L. B., Arnold W. (1951): *Light production by green plants*. *Journal of Genetics and Physiology* 34, pp. 809—820.
- Trifunović V. (1986): *Četrdeset godina moderne selekcije kukuruza u Jugoslaviji*. In: „Genetika i oplemenjivanje kukuruza. Dostignuća i nove mogućnosti”, str. 5—46, Beograd
- Veselovski V. A., Veselova T. V. (1990): *Luminiscent Characteristic of Plants Photosynthetic Apparatus*. In: „Luminescence of Plants”. Ed. Nauka, Moscow, pp. 8—78.
- Vučinić, Ž., B. Nešić & Č. Radeno vić (1982): *Delayed fluorescence as an in situ probe of fluidity changes in maize photosynthetic apparatus*. *Period. biol.* 84: 223—226.
- Раденович Ч., М. Еремич, Д. Маркович (1994а): *Фотоиндукционная биолюминесценция растительных систем: фотосинтетические, транспортные и мембранные процессы*. *Физиология и биохимия культурных растений* 26 (5): стр. 419—433.

МЕЂУЗАВИСНОСТ ОСЦИЛАЦИЈА И ТРАНЗИЈЕНАТА ИНДУКЦИОНИХ ПРОЦЕСА ЗАКАСНЕЛЕ ФЛУОРЕСЦЕНЦИЈЕ ХЛОРОФИЛА У ТИЛАКОИДНОЈ МЕМБРАНИ ИНТАКТНОГ ЛИСТА КУКУРУЗА — РЕАКЦИЈЕ НА ДЕЛОВАЊЕ ВИШИХ ТЕМПЕРАТУРА И СУШЕ

Чедомир Н. Раденовић^{1, 2}, Ксенија П. Марковић¹, Александар Р. Радојчић¹, Виолета Б. Анђелковић¹, Александар Ј. Калаузи³

¹ Институт за кукуруз „Земун Поље”, Београд, Србија

² Факултет за физичку хемију, Универзитет у Београду, Београд, Србија

³ Центар за мултидисциплинарне студије, Универзитет у Београду, Београд, Србија

Резиме

У овом раду остварује се примена побољшаног фотосинтетично-флуоресцентног метода у проучавању сложених индукционих процеса закаснеле флуоресценције (ЗФ) хлорофила, који су разложени на транзијенте: А, Б, Ц, Д и Е и код којих могу да настану осцилације. Међузависност осцилација и индукционих транзијената: А, Б, Ц, Д и Е јавља се код интактних листова линија (ЗПР 70ж и Oh 43) и хибрида (ЗПДЦ 360, ЗПСЦ 46А, ЗПСЦ 704 и ЗПСЦ 71) кукуруза који су гајени у стаклари у условима различите ваздушне суше, деловања виших температура и дефицита воде у подлози.

Посебно се указује на услове при којима долази до успостављања стандардних индукционих процеса 3Ф хлорофила. Даје се краћи опис стандардне индукционе криве 3Ф хлорофила. Знатно детаљније дају се експериментални резултати о разлагању индукционих процеса 3Ф хлорофила на транзијенте: А, Б, Ц, Д и Е. Показани су временски и физичко-хемијски параметри за проучаване индукционе транзијенте. Објашњени су њихова природа и механизми настајања.

Утврђене су карактеристике и механизам настајања осцилација индукционих процеса 3Ф хлорофила. Дати су услови при којима долази до појаве побуђеног стања, настајања флукуација и успостављања осцилација индукционих процеса 3Ф хлорофила у тилакоидној мембрани интактног листа линија и хибрида кукуруза. Изнета је хипотеза о механизму настајања осцилација. Објашњена је међузависност успостављања осцилација и транзијентата индукционих процеса 3Ф хлорофила.